

Raspberry Pi Pico Essentials

Program, build, and master over 50 projects with MicroPython and the RP2040 microprocessor

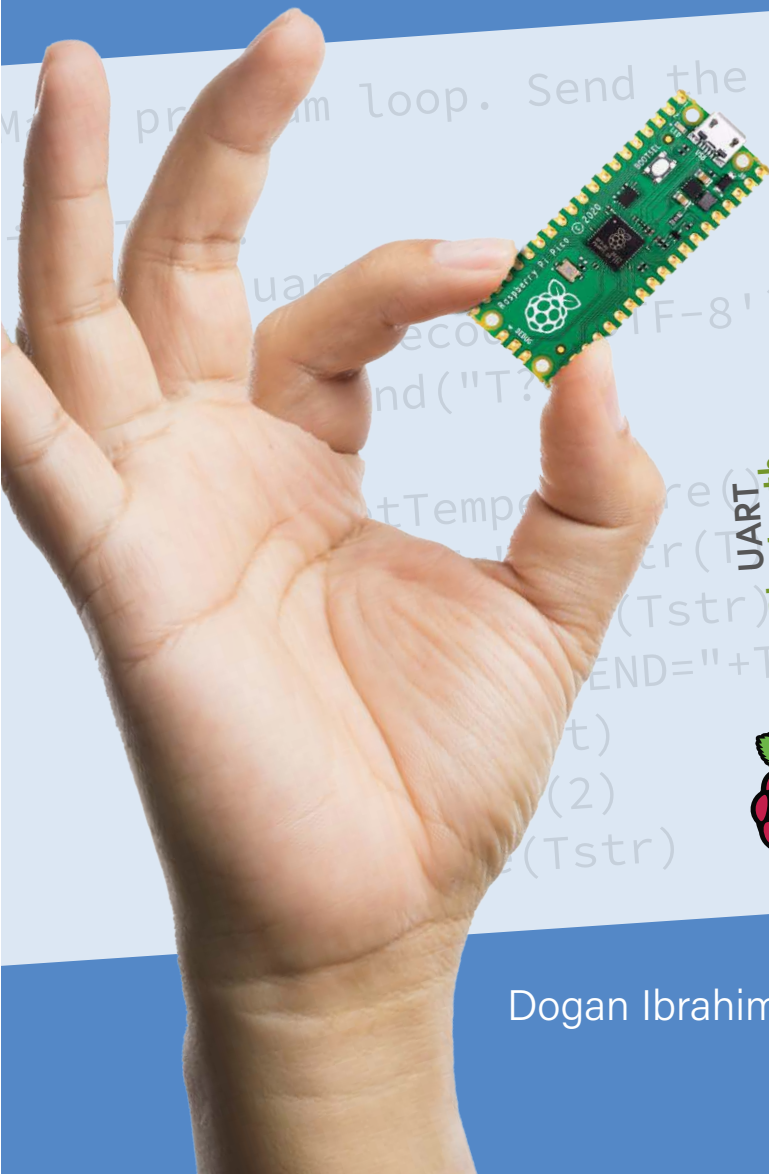

GPIO
Wi-Fi
TMP102
RS-232
Autorun
App
Brushed-DC
Hello World!
Breadboard
LED
I²S
EEPROM
DAC & ADC
7-segment
BME-280
RP2040



Dogan Ibrahim

Raspberry Pi Pico Essentials

Program, build, and master over 50 projects with
MicroPython and the RP2040 microprocessor



Dogan Ibrahim

● This is an Elektor Publication. Elektor is the media brand of
Elektor International Media B.V.
PO Box 11, NL-6114-ZG Susteren, The Netherlands
Phone: +31 46 4389444

● All rights reserved. No part of this book may be reproduced in any material form, including photocopying, or storing in any medium by electronic means and whether or not transiently or incidentally to some other use of this publication, without the written permission of the copyright holder except in accordance with the provisions of the Copyright Designs and Patents Act 1988 or under the terms of a licence issued by the Copyright Licencing Agency Ltd., 90 Tottenham Court Road, London, England W1P 9HE. Applications for the copyright holder's permission to reproduce any part of the publication should be addressed to the publishers.

● **Declaration**

The Author and the Publisher have used their best efforts in ensuring the correctness of the information contained in this book. They do not assume, and hereby disclaim, any liability to any party for any loss or damage caused by errors or omissions in this book, whether such errors or omissions result from negligence, accident or any other cause.

● **British Library Cataloguing in Publication Data**

A catalogue record for this book is available from the British Library

- **ISBN 978-3-89576-427-1** Print
- **ISBN 978-3-89576-428-8** eBook
- **ISBN 978-3-89576-429-5** ePub

- © Copyright 2021: Elektor International Media B.V.
Prepress Production: D-Vision, Julian van den Berg

Elektor is part of EIM, the world's leading source of essential technical information and electronics products for pro engineers, electronics designers, and the companies seeking to engage them. Each day, our international team develops and delivers high-quality content - via a variety of media channels (including magazines, video, digital media, and social media) in several languages - relating to electronics design and DIY electronics. www.elektormagazine.com

Preface	9
Chapter 1 • Raspberry Pi Pico Hardware	11
1.1 Overview	11
1.2 Pico hardware module	11
1.3 Comparison with the Arduino UNO	13
1.4 Operating conditions and powering the Pico	14
1.5 Pinout of the RP2040 microcontroller and Pico module	14
1.6 Other RP2040 microcontroller-based boards	16
1.6.1 Adafruit Feather RP2040	16
1.6.2 Adafruit ItsyBitsy RP2040	17
1.6.3 Pimoroni PicoSystem	17
1.6.4 Arduino Nano RP2040 Connect	18
1.6.5 SparkFun Thing Plus RP2040	18
1.6.6 Pimoroni Pico Explorer Base	19
1.6.7 SparkFun MicroMod RP2040 Processor	20
1.6.8 SparkFun Pro Micro RP2040	20
1.6.9 Pico RGB Keypad Base	20
1.6.10 Pico Omnibus	21
1.6.11 Pimoroni Pico VGA Demo Base	21
Chapter 2 • Raspberry Pi Pico Programming	23
2.1 Overview	23
2.2 Installing MicroPython on the Pico	23
2.2.1 Using a Raspberry Pi 4 to aid installing MicroPython on the Pico	23
2.2.2 Using a PC (Windows 10) to help install MicroPython on Pico	29
Chapter 3 • Raspberry Pi Pico Simple Hardware Projects	48
3.1 Overview	48
3.2 Project 1: Flashing LED – Using the on-board LED	48
3.3 Project 2: External flashing LED	51
3.4 Project 3: Flashing SOS in Morse	53
3.5 Project 4: Flashing LED – using a timer	55
3.6 Project 5: Alternately flashing LEDs	56
3.7 Project 6: Changing the LED flashing rate – using pushbutton interrupts	58

3.8 Project 7: Alternately flashing red, green, and blue LEDs — RGB	63
3.9 Project 8: Randomly flashing red, green, and blue LEDs — RGB	65
3.10 Project 9: Rotating LEDs.	66
3.11 Project 10: Binary-counting LEDs.	69
3.12 Project 11: Christmas lights (random flashing 8 LEDs)	72
3.13 Project 12: Electronic dice	74
3.14 Project 13: Lucky day of the week	78
3.15 Project 14: Door alarm with 7-colour flashing LED	80
3.16 Project 15: 2-digit, 7-segment display	84
3.17 Project 16: 4-digit, 7-segment display seconds counter	93
3.18 LCDs	98
3.19 Project 17: LCD functions – displaying text.	100
3.20 Project 18: Seconds counter — LCD	104
3.21 Project 19: Reaction timer with LCD.	106
3.22 Project 20: Ultrasonic distance measurement	108
3.23 Project 21: Height of a person (stadiometer)	112
3.24 Project 22: Ultrasonic reverse parking aid with buzzer	114
Chapter 4 • Using Analogue-To-Digital Converters (ADCs)	117
4.1 Overview	117
4.2 Project 1: Voltmeter.	117
4.3 Project 2: Temperature measurement – using the internal temperature sensor. . .	119
4.4 Project 3: Temperature measurement – using an external temperature sensor . .	120
4.5 Project 4: ON/OFF temperature controller.	122
4.6 Project 5: ON/OFF temperature controller with LCD	125
4.7 Project 6: Measuring the ambient light intensity	128
4.8 Project 7: Ohmmeter	130
4.9 Project 8: Internal and external temperature	133
4.10 Project 9: Using a thermistor to measure temperature	135
Chapter 5 • Data Logging	140
5.1 Overview	140
5.2 Project 1: Logging the temperature data	140
5.3 Project 2: Reading the logged data	142

Chapter 6 • Pulse Width Modulation (PWM)	144
6.1 Overview	144
6.2 Basic theory of pulsewidth modulation	144
6.3 PWM channels of the Raspberry Pi Pico	146
6.4 Project 1: Generate a 1000 Hz PWM waveform with 50% duty cycle	147
6.5 Project 2: Changing the brightness of an LED	148
6.6 Project 3: Varying the speed of a brushed DC motor	149
6.7 Project 4: Frequency generator with LCD	150
6.8 PROJECT 5: Measuring the frequency and duty cycle of a PWM waveform	152
6.9 PROJECT 6: Melody maker	154
Chapter 7 • Serial Communication (UART)	158
7.1 Overview	158
7.2 Raspberry Pi Pico UART serial ports	160
7.3 Project 1: Sending the Raspberry Pi Pico internal temperature to an Arduino Uno	160
7.4 Project 2: Receiving and displaying numbers from the Arduino Uno	165
7.5 Project 3: Communicating with the Raspberry Pi 4 over the serial link	166
Chapter 8 • The I²C Bus Interface	170
8.1 Overview	170
8.2 The I ² C Bus	170
8.3 I ² C pins of the Raspberry Pi Pico	171
8.4 Project 1: I ² C port expander	172
8.5 Project 2: EEPROM memory	177
8.6 Project 3: TMP102 temperature sensor	182
8.7 Project 4: BMP280 temperature and atmospheric pressure sensor	188
8.8 Project 5: Display BMP280 temperature and atmospheric pressure on an LCD	196
Chapter 9 • The SPI Bus Interface	198
9.1 Overview	198
9.2 Raspberry Pi Pico SPI ports	199
9.3 Project 1: SPI Port expander	200
Chapter 10 • Wi-Fi with the Raspberry Pi Pico	206
10.1 Overview	206
10.2 Project 1: Controlling an LED from a smartphone using Wi-Fi	206

- 10.3 Project 2: Displaying the internal temperature on a smartphone using Wi-Fi . . . 212
- Chapter 11 • Bluetooth with the Raspberry Pi Pico 217**
- 11.1 Overview 217
- 11.2 Raspberry Pi Pico Bluetooth interface 217
- 11.3 Project 1: Controlling an LED from your smartphone using Bluetooth. 217
- 11.4 Project 2: Sending the Raspberry Pi Pico's internal temperature to the smartphone. 222
- Chapter 12 • Using Digital-to-Analogue Converters (DACs) 225**
- 12.1 Overview 225
- 12.2 The MCP4921 DAC. 225
- 12.3 Project 1: Generating squarewave signal with amplitude under +3.3 V 226
- 12.4 Project 2: Generating fixed voltages 231
- 12.5 Project 3: Generating a sawtooth signal 233
- 12.6 Project 4: Generating a triangular signal. 235
- 12.7 Project 5: Arbitrary periodic waveform 237
- 12.8 Project 6: Generating a sinewave 239
- 12.9 Project 7: Generating an accurate sinewave signal using timer interrupts. 242
- Chapter 13 • Automatic Program Execution after the Raspberry Pi Pico Boots . . 245**
- Appendix A • Bill of Components 247**
- Index 248**

Preface

Traditionally, a computer was built using a microprocessor chip and many external support chips. A microprocessor includes a Central Processing Unit (CPU), an Arithmetic and Logic Unit (ALU), and timing and control circuitry — and as such it is not particularly useful on its own. A microprocessor must be supported by many external chips such as memory, input/output, timers, interrupt circuits etcetera, before it becomes a useful computer. The disadvantage of this type of design was that the chip count was large, resulting in complex design and wiring, and high power consumption.

A microcontroller on the other hand is basically a single chip computer including a CPU, memory, input/output circuitry, timers, interrupt circuitry, clock circuitry, and several other circuits and modules, all housed in a single silicon chip. Early microcontrollers were limited in their capacities and speed and they consumed considerably more power. Most of the early microcontrollers were 8-bit processors with clock speeds in the region of several MHz and offered only hundreds of bytes of program and data memories. These microcontrollers were traditionally programmed using the assembly languages of the target processors. 8-bit microcontrollers are still in common use, especially in small projects where large amounts of memory or high speed are not the main requirements. With the advancement of chip technology we now have 32-bit and 64-bit microcontrollers with speeds in the region of several GHz and offering several GB of memory space. Microcontrollers are nowadays programmed using a high-level language such as C, C#, BASIC, PASCAL, JAVA, etc.

The Raspberry Pi Pico is a high-performance microcontroller, designed especially for physical computing. Readers should realize that microcontrollers are very different from single-board computers like the Raspberry Pi 4 (and other family members of the Raspberry Pi). There is no operating system on the Raspberry Pi Pico. Microcontrollers like the Raspberry Pi Pico can be programmed to run a single task and they can be used in fast real-time control and monitoring applications.

The Raspberry Pi Pico is based on the fast and very efficient dual-core ARM Cortex-M0+ RP2040 microcontroller chip running at up to 133 MHz. The chip incorporates 264 KB of SRAM and 2 MB of Flash memory. What makes the Raspberry Pi Pico very attractive is its large number of GPIO pins, and commonly used peripheral interface modules, such as SPI, I²C, UART, PWM, plus fast and accurate timing modules.

Perhaps the biggest advantage of the Raspberry Pi Pico compared to other many microcontrollers in the marketplace is its very low cost, large memory, and fast and accurate timing modules. At the time of writing this book the cost of a single unit was around \$6.

Raspberry Pi Pico can easily be programmed using some of the popular high-level languages such as MicroPython, or C/C++. There are many application notes, tutorials, and data-sheets available on the Internet covering the use of the Raspberry Pi Pico.

This book is an introduction to using the Raspberry Pi Pico microcontroller with the MicroPython programming language. The Thonny development environment (IDE) is used in all the projects in the book, and readers are recommended to use this IDE. There are over 50 working and tested projects in the book, covering almost all aspects of the Raspberry Pi Pico.

The following sub-headings are given for each project to make it easy to follow:

- Title
- Brief Description
- Aim
- Block Diagram
- Circuit Diagram
- Program Listing with full description

I hope your next microcontroller-based projects make use of the Raspberry Pi Pico, and this book becomes useful in the development of your projects.

Dr Dogan Ibrahim

London, February, 2021

Chapter 1 • Raspberry Pi Pico Hardware

1.1 Overview

The Raspberry Pi Pico is a single-board microcontroller module developed by the Raspberry Pi Foundation. This module is based on the RP2040 microcontroller chip. In this Chapter we will be looking at the hardware details of the Raspberry Pi Pico microcontroller module in some detail. From here on, we will be calling this microcontroller module "Pico" for short, in for appreciation and recognition though of its official name: Raspberry Pi Pico.

1.2 Pico hardware module

The "Pico" is a very low-cost, \$4 microcontroller module based on the RP2040 microcontroller chip having a dual Cortex-M0+ processor. Figure 1.1 shows the front view of the Pico hardware module which is basically a small board. At the centre of the board is the tiny, 7×7 mm RP2040 microcontroller chip housed in a QFN-56 package. At the two edges of the board there are 40 gold-coloured metal GPIO (General-Input-Output) pins with holes. Soldering pins to these holes enables external connections to be easily made to the board. The holes are marked starting with number 1 at the top left corner of the board and the numbers increase downwards up to number 40 which is at the top right-hand corner of the board. The board is breadboard-compatible (i.e. 0.1-inch pin spacing), and after soldering the pins, the board can be plugged on a breadboard for easy connection to the GPIO pins using jumper wires. Next to these holes you will see bumpy circular cut-outs which can be plugged in on top of other modules without having any physical pins fitted.



Figure 1.1: Front view of the Pico hardware module.

At one edge of the board there is the micro-USB B port for supplying power to the board as well as for programming it. Next to the USB port there is an on-board user LED that can be used during program development. Next to this LED sits a button named as BOOTSEL that is used during programming of the microcontroller as we will see in next Chapters. At the other edge of the board, next to the Raspberry Pi logo, there are 3 connectors that can be used for debugging your programs.

Figure 1.2 shows the back view of the Pico hardware module. Here, all the GPIO pins are identified with letters and numbers. You will notice the following types of letters and numbers:

GND	-	power supply ground (digital ground)
AGND	-	power supply ground (analogue ground)
3V3	-	+3.3 V power supply (output)
GP0 – GP22	-	digital GPIO
GP26_A0 – GP28_A2	-	analogue inputs
ADC_VREF	-	ADC reference voltage
TP1 – TP6	-	test points
SWDIO, GND, SWCLK	-	debug interface
RUN	-	default RUN pin. Connect LOW to reset the RP2040.
3V3_EN	-	this pin by default enables the +3.3V power supply. +3.3 V can be disabled by connecting this pin LOW.
VSYS	-	system input voltage (1.8 V to 5.5 V) used by the on-board SMPS to generate +3.3 V supply for the board.
VBUS	-	micro-USB input voltage (+5 V)

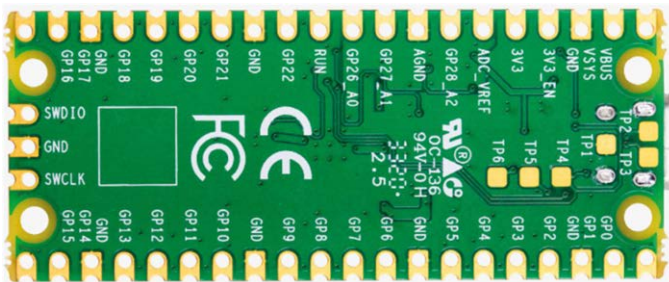

Figure 1.2: Back view of the Pico hardware module.

Some of the GPIO pins are used for internal board functions. These are:

GP29 (input)	-	used in ADC mode (ADC3) to measure VSYS/3
GP25 (output)	-	connected to on-board user LED
GP24 (input)	-	VBUS sense - HIGH if VBUS is present, else LOW
GP23 (output)	-	Controls the on-board SMPS Power Save pin

The specifications of the Pico hardware module are as follows:

- 32-bit RP2040 Cortex-M0+ dual core processor operating at 133 MHz
- 2 Mbyte Q-SPI Flash memory
- 264 Kbyte SRAM memory
- 26 GPIO (+3.3V compatible)
- 3× 12-bit ADC pins
- Serial Wire Debug (SWD) port
- Micro-USB port (USB 1.1) for power (+5V) and data (programming)
- 2× UART, 2 × I²C, 2 × SPI bus interface
- 16× PWM channels
- 1× Timer (with 4 alarms), 1× Real-Time Counter
- On-board temperature sensor

- On-board LED (on port GP25)
- MicroPython, C, C++ programming
- Drag & drop programming using mass storage over USB

The Pico's GPIO hardware is +3.3 V compatible and it is therefore important to be careful not to exceed this voltage when interfacing external input devices to the GPIO pins. +5 V to +3.3 V logic converter circuits or resistive potential divider circuits must be used if it is required to interface devices with +5 V outputs to the Pico GPIO pins.

Figure 1.3 shows a resistive potential divider circuit that can be used to lower +5 V to +3.3 V.

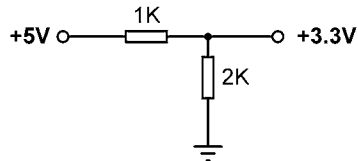

Figure 1.3: resistive potential divider circuit.

1.3 Comparison with the Arduino UNO

The Arduino UNO is one of the most popular microcontroller development boards used by students, practicing engineers, and hobbyists. Table 1.1 shows a comparison of the Raspberry Pi Pico with the Arduino UNO. It is clear from this table that the Pico is much faster than the Arduino UNO, having larger flash and data memories, providing more digital input/output pins, and sporting an on-board temperature sensor. The Arduino UNO operates at +5 V and its GPIO pins are +5 V compatible. Perhaps some advantages of the Arduino UNO include having a built-in EEPROM memory, and having a 6-channel ADC rather than a 3-channel.

Feature	Raspberry Pi Pico	Arduino UNO
Microcontroller	RP2040	Atmega328P
Core and bits	Dual core, 32-bit, Cortex-M0+	Single-core 8-bit
RAM	264 Kbytes	2 Kbytes
Flash	2 Mbytes	32 Kbytes
CPU speed	48 MHz to 133 MHz	16 MHz
EEPROM	None	1 KByte
Power input	+5 V through USB port	+5V through USB port
Alternative power	2–5 V via V _{SY} S pin	7–12 V
MCU operating voltage	+3.3 V	+5 V
GPIO count	26	20
ADC count	3	6
Hardware UART	2	1
Hardware I2C	2	1
Hardware SPI	2	1
Hardware PWM	16	6
Programming languages	MicroPython, C, C++	C (Arduino IDE)
On-board LED	1	1
Cost	\$4	\$20

Table 1.1: Comparison of Raspberry Pi Pico and Arduino UNO.

1.4 Operating conditions and powering the Pico

The recommended operating conditions for the Pico are:

- Operating temperature: -20°C to $+85^{\circ}\text{C}$
- VBUS voltage: $+5\text{ V} \pm 10\%$
- VSYS voltage: $+1.8\text{ V}$ to $+5.5\text{ V}$

An on-board SMPS is used to generate the $+3.3\text{ V}$ to power the RP2040 from a range of input voltages from 1.8 V to $+5.5\text{ V}$. For example, 3 alkaline size-AA batteries can be used to provide $+4.5\text{ V}$ to power the Pico.

The Pico can be powered in several ways. The simplest method is to plug the micro-USB port into a $+5\text{ V}$ power source, such as the USB port of a computer or a $+5\text{ V}$ power adapter. This will provide power to the VSYS input (see Figure 1.4) through a Schottky diode. The voltage at the VSYS input is therefore VBUS voltage minus the voltage drop of the Schottky diode (about $+0.7\text{ V}$). VBUS and VSYS pins can be shorted if the board is powered from an external $+5\text{ V}$ USB port. This will increase the voltage input slightly and hence reduce ripples on VSYS. VSYS voltage is fed to the SMPS through the RT6150 which generates fixed $+3.3\text{ V}$ for the MCU and other parts of the board. VSYS is divided by 3, and is available at analogue input port GPIO29 (ADC3) which can easily be monitored. GPIO24 checks the existence of VBUS voltage and is at logic HIGH if VBUS is present.

Another method to power the Pico is by applying external voltage ($+1.8\text{ V}$ to $+5.5\text{ V}$) to the VSYS input directly (e.g., using batteries or external power supply). We can also use the USB input and VSYS inputs together to supply power to Pico, for example to operate with both batteries and the USB port. If this method is used, then a Schottky diode should be used at the VSYS input to prevent the supplies from interfering with each other. The higher of the voltages will power VSYS.

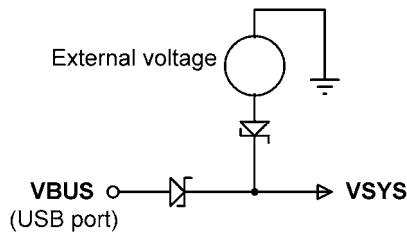

Figure 1.4: Powering the Pico.

1.5 Pinout of the RP2040 microcontroller and Pico module

Figure 1.5 shows the RP2040 microcontroller pinout, which is housed in a 56-pin package. The Pico module pinout is shown in Figure 1.6 in detail. As you can see from the illustration, most pins have multiple functions. For example, GPIO0 (pin 1) doubles as the UART0 TX, I2C0 SDA, and the SPI0 RX pin.

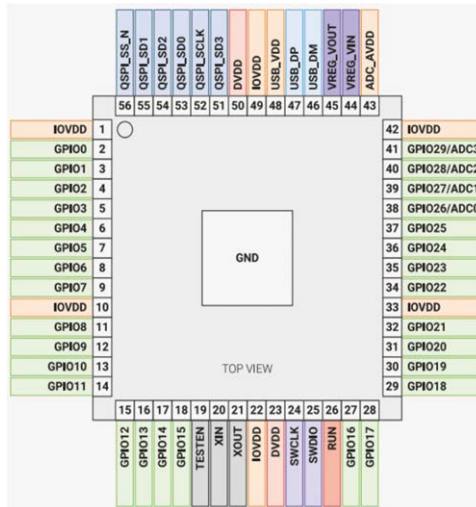

Figure 1.5: RP2040 microcontroller pinout.

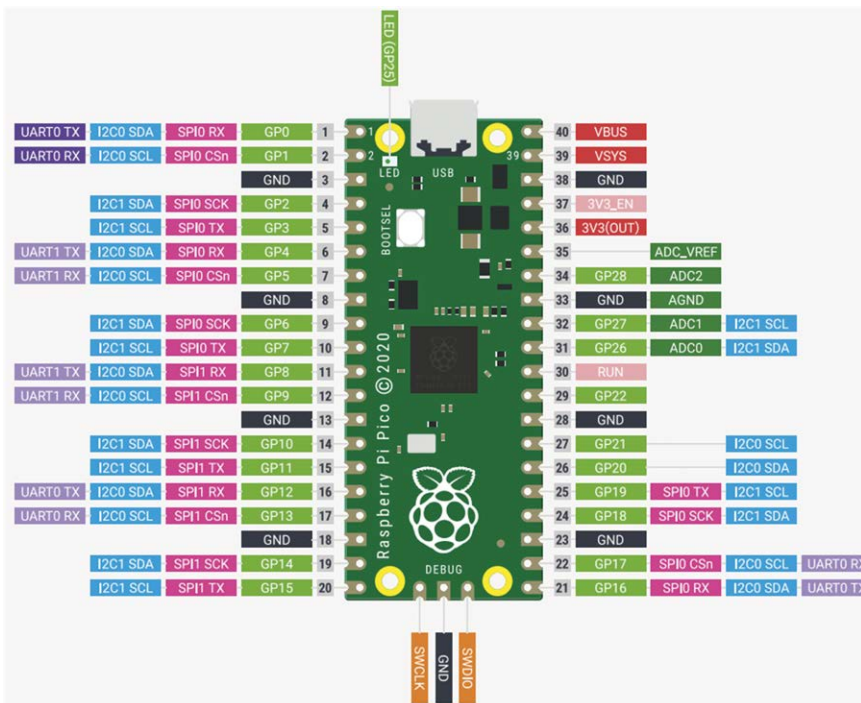

Figure 1.6: Raspberry Pi Pico pinout.

Figure 1.7 shows a simplified block diagram of the Pico hardware module. Notice that the GPIO pins are directly connected from the microcontroller chip to the GPIO connector. GPIO nos. 26-28 can be used either as digital GPIO or as ADC inputs. ADC inputs GPIO26-29 have reverse-biased diodes to 3 V and therefore the input voltage must not exceed 3V3 +

300 mV. Another point to note is that if the RP2040 is not powered, applying voltages to GPIO26-29 pins may leak through the diode to the power supply (there is no problem with the other GPIO pins and voltage can be applied when the RP2040 is not powered).

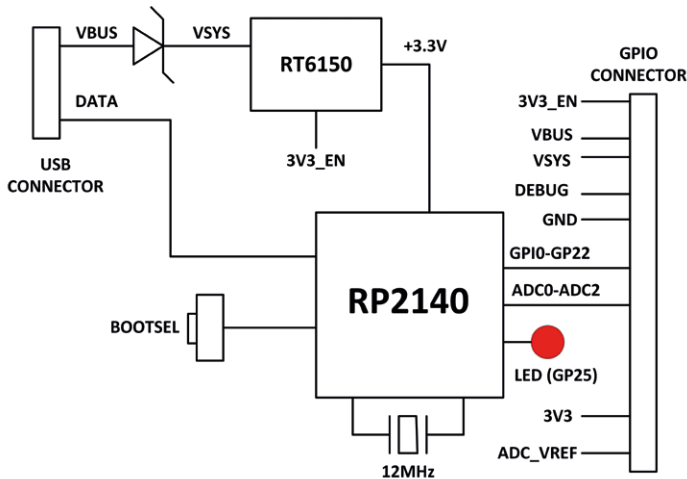

Figure 1.7: Simplified block diagram.

1.6 Other RP2040 microcontroller-based boards

During the writing of this book, some third-party manufacturers have been developing microcontrollers based on the RP2040 chip. Some examples are given in this section.

1.6.1 Adafruit Feather RP2040

This microcontroller board (Figure 1.8) has the following basic specifications:

- RP2040 32-bit Cortex-M0+ running at 125 MHz
- 4 MB Flash memory
- 264 KB RAM
- 4× 12-bit ADC
- 2× I²C, 2× SPI, 2× UART
- 16× PWM
- 200 mA LiPo charger
- Reset and Bootloader buttons
- 24 MHz crystal
- +3.3 V regulator with 500 mA current output
- USB type-C connector
- on-board red LED
- RGB NeoPixel
- on-board STEMMA QT connector with optional SWD debug port

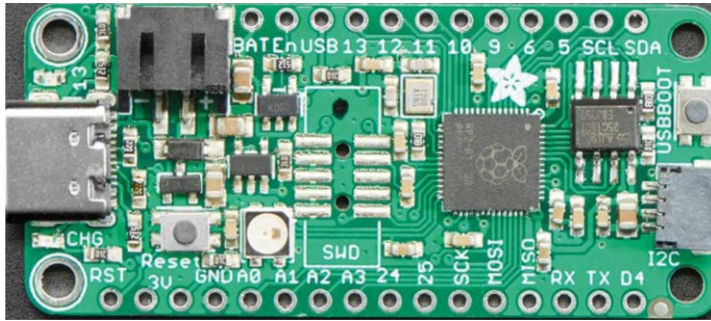

Figure 1.8: Adafruit Feather RP2040.

1.6.2 Adafruit ItsyBitsy RP2040

The ItsyBitsy RP2040 (Figure 1.9) is another RP2040-based microcontroller board from Adafruit. Its basic features are very similar to Feather RP2040. It has USB-micro B connector and provides +5 V output.

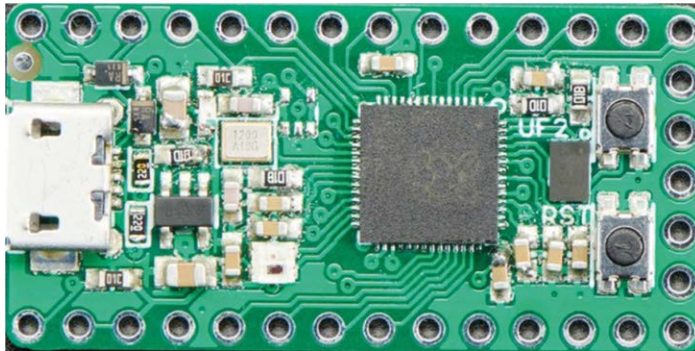

Figure 1.9: Adafruit ItsyBitsy RP2040.

1.6.3 Pimoroni PicoSystem

This is a miniature gaming board (Figure 1.10) developed around the RP2040 microcontroller. Its basic features are:

- 133 MHz clock
- 264 KB SRAM
- LCD screen
- joypad
- buttons
- LiPo battery
- USB-C power connector



Figure 1.10: Pimoroni PicoSystem.

1.6.4 Arduino Nano RP2040 Connect

This board (Figure 1.11) offers 16 MB flash, 9-axis IMU, and a microphone. It has a very efficient power supply section equipped with Wi-Fi/Bluetooth.

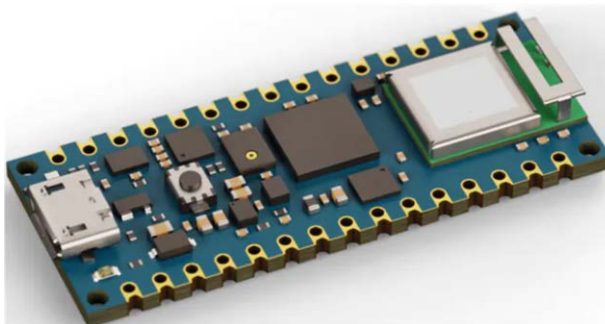

Figure 1.11: Arduino Nano RP2040 Connect.

1.6.5 SparkFun Thing Plus RP2040

This development platform (Figure 1.12) provides an SD card slot, 16 MB flash memory, a JST single-cell battery connector, a WS2812 RGB LED, JTAG pins, and Qwiic connector. Its basic features are:

- 133 MHz speed
- 264 KB SRAM
- 4× 12-bit ADC
- 2× UART, 2× I²C, 2× SPI
- 16× PWM
- 1× timer with 4 alarms

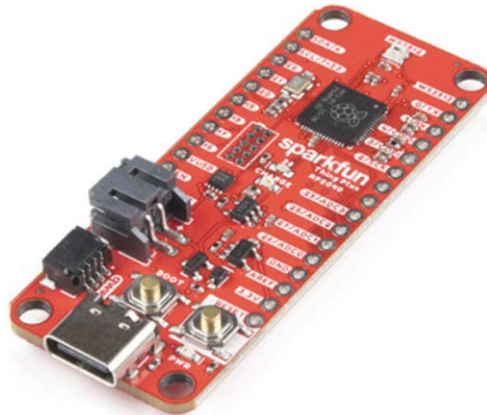

Figure 1.12: SparkFun Thing Plus RP2040.

1.6.6 Pimoroni Pico Explorer Base

This development board (Figure 1.13) includes a small breadboard and a 240 × 240 IPS LC display with 4 tactile buttons. A socket is provided on the board to plug-in a Raspberry Pi Pico board. The basic features of this development board are:

- piezo speaker
- 1.54-inch IPS LCD
- 4× buttons
- 2× half-bridge motor drives
- two breakout I²C sockets
- easy access to GPIO and ADC pins
- mini breadboard
- no soldering required
- Raspberry Pi Pico not supplied

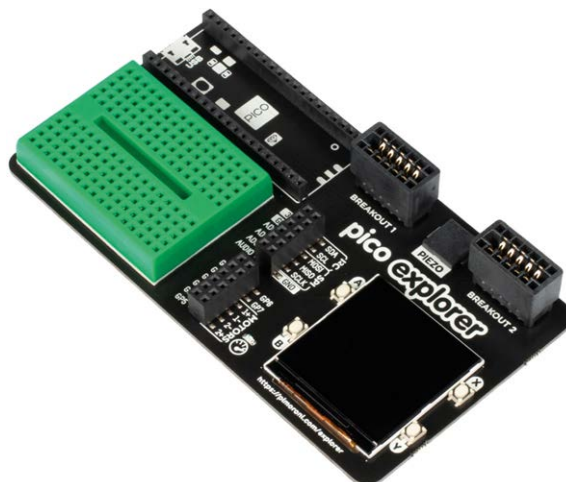

Figure 1.13: Pimoroni Pico Explorer Base.

1.6.7 SparkFun MicroMod RP2040 Processor

This board (Figure 1.14) includes a MicroMod M.2 connector for access to the GPIO pins.

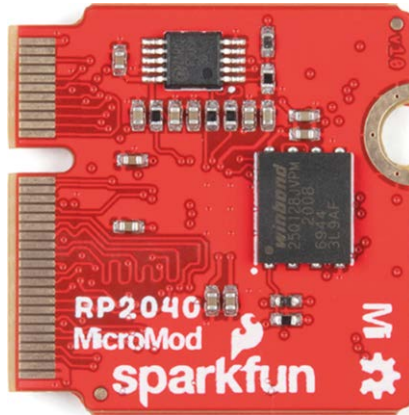

Figure 1.14: SparkFun MicroMod RP 2040 Processor.

1.6.8 SparkFun Pro Micro RP2040

This board (Figure 1.15) includes a ES2812B addressable LED, boot button, reset button, Qwiic connector, USB-C power interface, PTC fuse, and castellated GPIO pads.

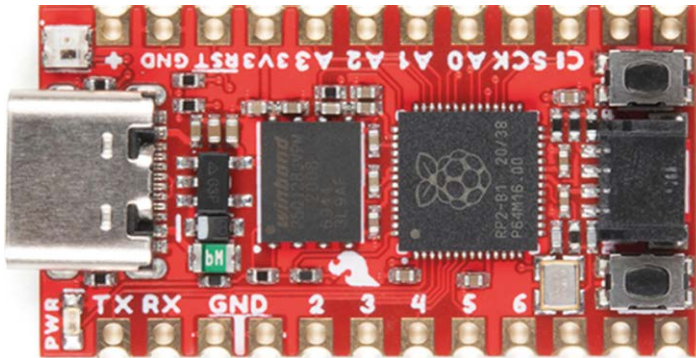

Figure 1.15: SparkFun Pro Micro RP2040.

1.6.9 Pico RGB Keypad Base

This board is equipped with 4×4 rainbow-illuminated keypad (Figure 1.16) with APA102 LEDs. The basic features are:

- 4×4 keypad
- 16× APA102 RGB LEDs
- keypad connected via I²C I/O expander
- GPIO pins labelled

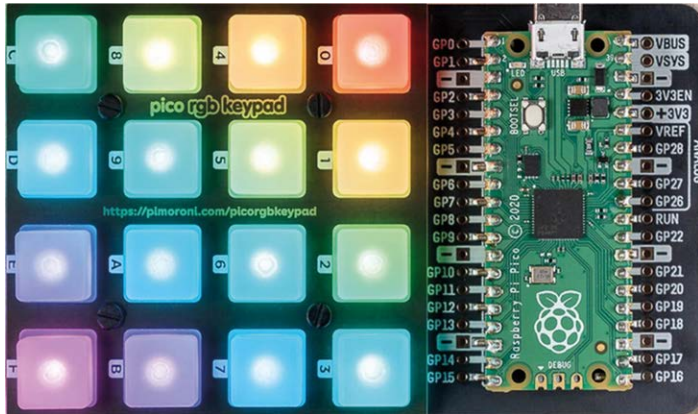

Figure 1.16 Pico RGB Keypad Base.

1.6.10 Pico Omnibus

This is an expansion board (Figure 1.17) for the Pico. The basic features of this board include:

- GPIO pins labelled
- two landing areas with labelled (mirrored) male headers for attaching add-ons
- 4× rubber feet
- compatible with Raspberry Pi Pico
- fully assembled
- dimensions approx. 94 × 52 × 12 mm

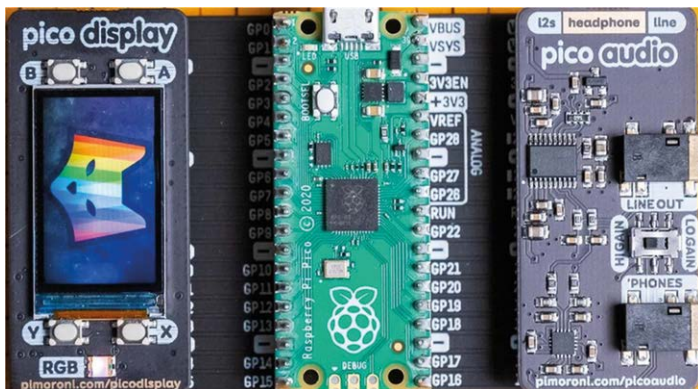

Figure 1.17: Pico Omnibus.

1.6.11 Pimoroni Pico VGA Demo Base

This board (Figure 1.18) has VGA output and SD card slot. The basic features are:

- powered by Raspberry Pi Pico
- 15-pin VGA connector
- I²S DAC for line out audio

- PWM audio output
- SD card slot
- Reset button
- headers to install your Raspberry Pi Pico
- three user switches
- no soldering required



Figure 1.18: Pimoroni Pico VGA Demo Base.

Index

Symbols

7-segment	84
24LC256	177

A

Accessories	25
accurate sinewave	242
Active buzzers	55
ADC3	14
ADC inputs	15
Arbitrary periodic waveform	237
Arduino UNO	13
atmospheric pressure	188

B

BC108	88
Binary-counting	69
Bluetooth	217
Bluetooth Controller	220
BMP280	188
Bootloader	16
BOOTSEL	11, 23, 29
brushed DC motor	149

C

Calculator	41
common-anode	85
common-cathode	85
Cortex-M0+	11
cosine	38
CPHA	199
CPOL	199
current-sinking	52
current-sourcing	52

D

DACs	225
Data Logging	140
DC56-11EWA	87
dice	74
Dice	42
distance measurement	108
Door alarm	80

E

EEPROM memory	177
echo	111
ESP-01	206
external temperature	133

F

Feather RP2040	17
File processing	43
Flash memory	12, 16
Frequency generator	150

H

HC-06	217
HC-SR04	109
HD44780	98

I

I ² C bus	170
I ² C pins	171
import machine	49
INDEX.HTM	24, 29
INFO_UF2.TXT	24
internal temperature sensor	119

K

keypad	20
KY-013	135
KY-021	80
KY-034	80

L

LDR	128
light intensity	128

M

machine	48
magnetic field	81
matrices	46
MCP23S17	200
MCP4921	225
Melody	154
Memory-read	180
Memory-write	179
MicroMod M.2 connector	20
micro-USB	11

MCP23017	173	sinewave	239
MOSFET	149	smartphone	206
multi-digit displays	86	SMPS	14
musical notes	155	Sorting	43
N		SPI Bus	198
NPN transistors	95	SPI Port expander	200
NTC	135	SPI ports	199
O		squarewave signal	226
Ohmmeter	130	SRAM	12
P		stadiometer	112
Passive buzzers	55	Steinhart-Hart	135
Polarity	185	SWD	12
port expander	172	T	
potentiometer	149	tangent	38
priority	59	temperature controller	122
Pulse Width Modulation	144	Temperature measurement	119
pushbutton	58, 75	temperature sensor	12
PWM	144	Text (UTF-8)	211
PWM channels	12, 146	thermistor	135
Q		Thonny	26
QFN-56 package	11	timer	55
R		timer interrupt	229
randint	42	TMP36	121
random flashing	72	TMP102	182
Random Read	180	triangular signal	235
Reaction timer	106	trig	111
reed switch	80	trigonometric sine	38
reverse parking aid	114	U	
RGB	63	UART	158
RPI-RP2	25	UDP Server	210
RS-232 communication	158	UDP/TCP Widget	210
RUN	12	Ultrasonic sensors	109
S		utime	48
sawtooth signal	233	V	
Schottky diode	14	VBUS	12
SCL	170	V logic converter	13
SDA	170	Voltmeter	117
serial link	166	VSYS	12, 14
serial ports	160	W	
Shell	27	wake	59
		Wi-Fi	206
		WS2812 RGB	18

Raspberry Pi Pico Essentials

Program, build, and master over 50 projects with MicroPython and the RPi 'Pico' microprocessor

The Raspberry Pi Pico is a high-performance microcontroller module designed especially for physical computing. Microcontrollers differ from single-board computers, like the Raspberry Pi 4, in not having an operating system. The Raspberry Pi Pico can be programmed to run a single task very efficiently within real-time control and monitoring applications requiring speed. The 'Pico' as we call it, is based on the fast, efficient, and low-cost dual-core ARM Cortex-M0+ RP2040 microcontroller chip running at up to 133 MHz and sporting 264 KB of SRAM, and 2 MB of Flash memory. Besides its large memory, the Pico has even more attractive features including a vast number of GPIO pins, and popular interface modules like ADC, SPI, I2C, UART, and PWM. To cap it all, the chip offers fast and accurate timing modules, a hardware debug interface, and an internal temperature sensor.

The Raspberry Pi Pico is easily programmed using popular high-level languages such as MicroPython and/or C/C++. This book is an introduction to using the Raspberry Pi Pico microcontroller in conjunction with the MicroPython programming language. The Thonny development environment (IDE) is used in all the projects described. There are over 50 working and tested projects in the book, covering the following topics:

- Installing the MicroPython on Raspberry Pi Pico using a Raspberry Pi or a PC
- Timer interrupts and external interrupts
- Analogue-to-digital converter (ADC) projects
- Using the internal temperature sensor and external temperature sensor chips
- Datalogging projects
- PWM, UART, I2C, and SPI projects
- Using Wi-Fi and apps to communicate with smartphones
- Using Bluetooth and apps to communicate with smartphones
- Digital-to-analogue converter (DAC) projects

All projects given in the book have been fully tested and are working. Only basic programming and electronics experience is required to follow the projects. Brief descriptions, block diagrams, detailed circuit diagrams, and full MicroPython program listings are given for all projects described. Readers can find the program listings on the Elektor web page created to support the book.



Prof. Dr. Dogan Ibrahim has a BSc, Hons. degree in Electronic Engineering, an MSc degree in Automatic Control Engineering, and a PhD degree in Digital Signal Processing.

Dogan has worked in many industrial organizations before he returned to academic life. He is the author of over 70 technical books and has published over 200 technical articles on electronics, microprocessors, microcontrollers, and related fields.

Elektor International Media BV
www.elektor.com

